

Instruction Manual
for
GSIMII Series Pneumatic Spray Nozzles

GSIM **37II, 55II (90-degree Angle Bend)

Preface	P. 1
Safety Precautions	P. 1
1. Suggestions & Cautions	P. 2
2. Components of Nozzle	P. 4
3. Disassembly	P. 5
4. Assembly	P. 5
5. Maintenance	P. 6
6. Troubleshooting	P. 6
7. Disposal	P. 7
8. Inquiries	P. 7

Preface

Thank you for purchasing the Spray Nozzle from H. Ikeuchi & Co., Ltd.

This manual gives detailed instructions for the basic handling, maintenance and cautions of the product.

Please be aware that due to continuing efforts to improve our products, some details in this manual may differ from the actual product.

After reading, keep this manual handy for quick reference.

Safety Precautions

Prior to use, read this manual carefully and familiarize yourself with the proper operation of the product for optimal performance.

H. Ikeuchi & Co., Ltd. takes no responsibility for any accidents and/or injuries resulting from improper handling, installation and/or operation.



Wear safety gloves.

Screw threads, edges and corners may be sharp and could cause injury.



Ensure that the nozzle is firmly installed.

Loose screws may cause the nozzle to come off during operation and lead to serious accidents.



Be aware of the nozzle temperature and do not perform

maintenance until it has cooled down enough to avoid burns.

1. Suggestions & Cautions

- (1) Nozzle must be dismantled and stored if it is not used for an extended period of time.
- (2) Avoid prolonged exposure of the nozzle to high temperatures when not in use to prevent corrosion.
- (3) Even when the installed nozzles are not in use, it is recommended to maintain a constant air supply at a pressure of 5 kPa, to protect nozzles from high temperature and dust accumulation.
- (4) To extend the life of the nozzles, purge them with air or using other methods.

CORRECT

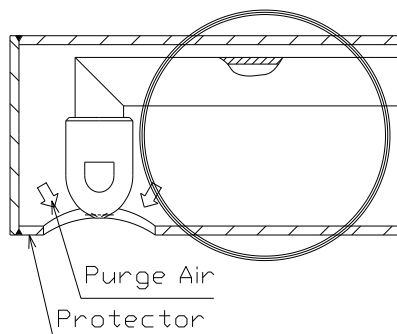

WRONG

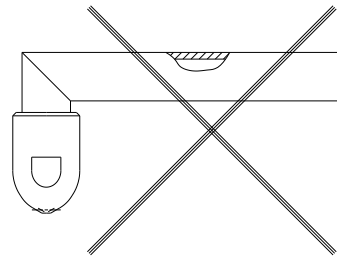

- (5) Always use a flange to install the nozzles to an incinerator or cooling tower and make sure to avoid excessive force when installing.
Never use anything but a flange to install the nozzles.
- (6) Nozzles may be heavy and need to be handled carefully.
Example: If the nozzles are shipped with protectors, they need to be installed separately; first the protector and then the nozzles. Piping connections for air and water supply should be installed after the nozzles have been installed.
- (7) Screw threads, edges and corners may be sharp.
Wearing safety gloves is recommended.
- (8) For GSIM II series with removable flange, when adjusting the flange, loosen the lock bolt and move the flange.
Make sure that the nozzle is kept horizontally while adjusting the flange.
- (9) Operate the nozzles under the specified pressures.
If the pressure is not specified, refer to the provided flow-rate diagram.
- (10) Avoid damaging or scratching the nozzles and pipes. When replacing a nozzle tip or disassembling the nozzle for maintenance, always use a spanner and milling vice.
DO NOT use a pipe vice, pipe wrench or pliers.

(11) Precautions to prevent liquids from back-flowing:

To start operation: Open the air supply first, then the liquid.

To stop operation: Shut off the liquid first, then the air.

(12) Air and liquid piping

- Use piping and valves large enough to prevent the pressure from dropping.
- Use new stainless steel pipes, as dust and debris in old pipes may clog the nozzles. Never use pipes that can rust.
- Even new pipes may have chips, seal tape or other debris inside. ALWAYS flush pipes thoroughly before installing nozzles to remove any debris that could cause clogging.
- Install pressure gauges just before the nozzle to adjust air and liquid pressures appropriately. Installation of a valve is also recommended.
- If a nozzle is clogged, its performance is impacted. Installing strainers helps prevent nozzle clogging.

(13) Prior to shipment all parts are firmly tightened. However, due to temperature changes during transport and especially if the nozzles are exposed to repeated heating and cooling during operation, parts such as screws may loosen and should therefore be inspected regularly. Take special care when screwing in and unscrewing to prevent damage.

Always apply an anti-seizing or sealing agent to the threads before assembly.

2. Components of Nozzle

(1) Nozzle Assembly

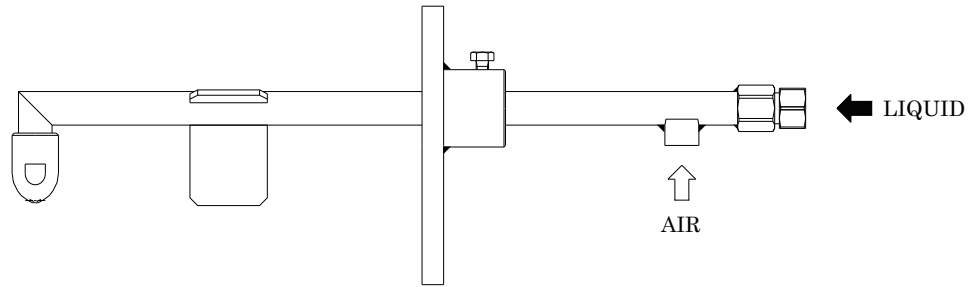

(2) Component Parts and Materials

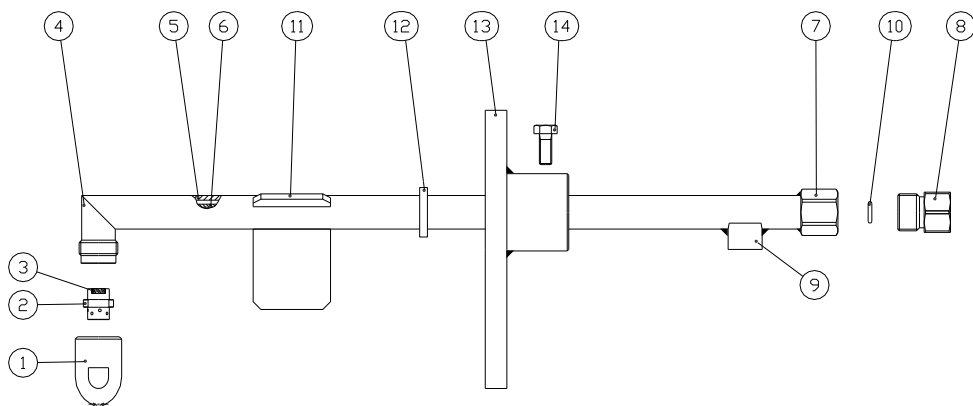

Part No.	Component	Material	Remark	Part No.	Component	Material	Remark
1	Nozzle Tip	S316L	Consumable	8	Liquid Socket	S304	
2	Nozzle Core	S316L	Consumable	9	Air Socket	S304	
3	Whirler	S316L equiv.	Consumable	10	O-ring	FKM	Consumable
4	Nozzle Adaptor	S316L		11	Plate	S304	
5	Pipe	S316L		12	Packing	Metal wire reinforced AES wool	Consumable
6	Pipe	S316L		13	Flange	S304	
7	Joint	S304		14	Bolt	S304	

Note:

(1) Consumables

The lifetime of a nozzle varies, depending on the operational conditions. Replace consumable parts when corrosion or pitting corrosion of a nozzle tip or other parts is found and/or nozzle performance significantly deteriorates.

(2) Dimensions and materials may differ depending on product codes.

(3) In the material code, "S" represents "stainless steel".

For example, S304 stands for stainless steel 304.

3. Disassembly

(1) Nozzle

After the nozzle has cooled down, secure the nozzle adaptor (#4) with a milling vice and unscrew the nozzle tip (#1) with a spanner to take out the nozzle core (#2).

Necessary tools: Milling vice, Spanner 27 mm

(2) Pipe

Use a milling vice to hold the joint (#7) and unscrew the liquid socket (#8) with a spanner to take out the O-ring (#10).

Necessary tools: Milling vice, Spanner 26 mm

Note:

- (1) A nozzle dismantled from an incinerator may be very hot, make sure the nozzle has cooled down sufficiently before disassembly.
- (2) Make sure not to drop, damage or lose any of the small parts.
- (3) The nozzle tip and orifice are the most important and delicate parts. Take extreme care when handling them.

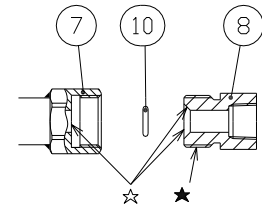
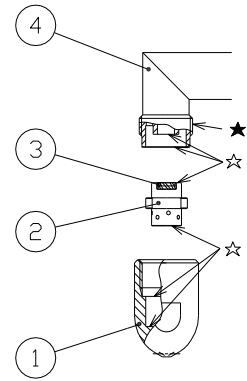

4. Assembly

Assemble in the reverse order of the above 3. Disassembly.

Nozzle

Insert the nozzle core (#2) into the nozzle tip (#1), making sure the whirler (#3) faces outward, towards the nozzle adaptor (#4). Pay special attention that the nozzle core (#2) is not inserted backwards.

Hand-tighten the nozzle tip (#1) into the nozzle adaptor (#4), then tighten it with a spanner.

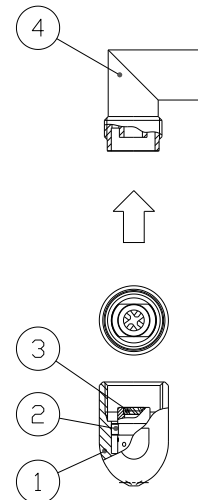

Note:

- (1) Before assembly, confirm that the sealing surfaces (indicated by ☆ above) and the orifice are clean and undamaged.
- (2) Remove dust and debris carefully from the orifice and sealing surfaces (indicated by ☆ above) with a brush to not damage these important surfaces.
- (3) Always apply anti-seizing agent to the threads (indicated by ★ above) before assembly.

5. Maintenance

Check	Item	Check points
Daily	Spray	Have a visual check of the spray pattern. Confirm that the spraying pressure is normal, when spray pattern cannot be seen because nozzles are in an incinerator.
	Pressure gauges and flow meters	Confirm that the air and liquid pressures and flow rate are correct during operation.
Periodically	Spray	Remove the nozzle from incinerator, spray and make a visual check of the spray pattern.
	Appearance	Confirm that there is no corrosion or dust adhesion to the nozzle tip and orifice.
	Connection	Confirm that nozzle tip and nozzle adaptor are connected properly and firmly.

6. Troubleshooting

Troubles	Probable causes		Solutions
No spray is being created	Control	<ul style="list-style-type: none"> • Controller is not switched on. • Valves are not opened. 	<ul style="list-style-type: none"> • Switch it on. • Open the valves.
	Nozzle	<ul style="list-style-type: none"> • Nozzle or pipe is clogged. • Nozzle or pipe is clogged due to damage. • Liquid orifice and/or air orifice is clogged. 	<ul style="list-style-type: none"> • Check and clean the nozzle and pipe. • Replace the damaged part. • Clean them.
Air leaks	<ul style="list-style-type: none"> • Some parts are loose or not tightened. 		<ul style="list-style-type: none"> • Tighten the connections.
Liquid leaks	<ul style="list-style-type: none"> • Nozzle or pipe is cracked. • Nozzle or pipe is corroded. 		<ul style="list-style-type: none"> • Replace the cracked part. • Replace the corroded part.
Intermittent spray	<ul style="list-style-type: none"> • Seal failure between the nozzle tip, core, and adaptor (air or liquid leaks due to dust/foreign particles adhered or damage on the sealing surface). • O-ring is damaged. 		<ul style="list-style-type: none"> • Clean the sealing surface and replace the part. • Replace O-ring.
Irregular spray pattern	<ul style="list-style-type: none"> • Nozzle or pipe is clogged. • Nozzle tip is corroded. • Dust or foreign particles adhered on the orifices. 		<ul style="list-style-type: none"> • Check and clean the nozzle and pipe. • Replace the corroded part. • Clean the parts.

7. Disposal

Disposal should be practiced according to the regulations and codes of local authorities, or ask a disposal professional.

8. Inquiries

For spare parts or any trouble, contact your supplier or the following:

H. IKEUCHI & CO., LTD.
Daiichi Kyogyo Bldg., 1-15-15, Awaza, Nishi-ku,
Osaka 550-0011 JAPAN
Tel: +81-6-6538-4015 Fax: +81-6-6538-4022
Email: overseas@kirinoikeuchi.co.jp
<https://www.kirinoikeuchi.co.jp/eng/>